

PROPRIETARY NOTICE

This document discloses confidential subject matter in which MilesTek Corporation and its subsidiaries have proprietary rights. Neither receipt nor possession thereof confers or transfers any right to reproduce or disclose the document, any part thereof, any information contained therein, or any physical article or device, or to practice any method or process, except by written permission from, or written agreement with MilesTek Corporation and its subsidiaries.

LEAD FREE SOLDER

REVISIONS			
REV	DESCRIPTION	DATE	APPROVED
A	REV A DRAWING RELEASED	04/09/2019	MHEARN

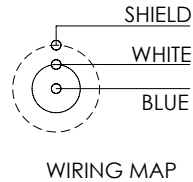
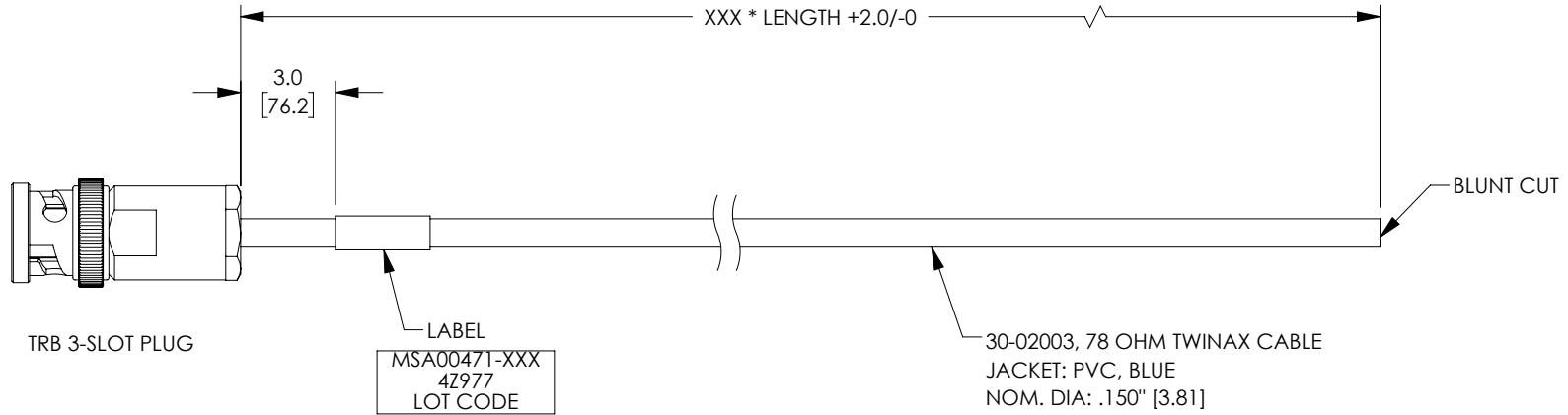

MODEL NUMBER	LENGTH METERS [FEET]
MSA00471-03M	0.3 [1.0]
MSA00471-05M	0.5 [1.64]
MSA00471-075M	0.75 [2.46]
MSA00471-1M	1.0 [3.28]
MSA00471-2M	2.0 [6.56]
MSA00471-3M	3.0 [9.84]
MSA00471-4M	4.0 [13.12]
MSA00471-6M	6.0 [19.69]

NOTES:

- *XXX = LENGTH IN INCHES
*XXXM = LENGTH IN METERS
- CABLE ASSEMBLY SHALL BE TESTED FOR CONTINUITY.
- ALL MATERIALS USED ARE CERTIFIED RoHS COMPLIANT.

<small>UNLESS OTHERWISE SPECIFIED ALL DIMENSIONS ARE IN INCHES</small> <small>OVERALL CABLE LENGTH TOLERANCE:</small> ≤12 [305] = +1 [25] / -0 >12 [305] ≤60 [1524] = +2 [51] / -0 >60 [1524] ≤120 [3048] = +4 [102] / -0 >120 [3048] ≤300 [7620] = +6 [152] / -0 >300 [7620] = +5% / -0% <small>ALL OTHER DIMENSIONAL TOLERANCES:</small> X = ± 2 [5.08] .XX = ± .02 [51] .XXX = ±.005 [1.3]	SIGNATURE	DATE	MILESTEK CORPORATION 301 LEORA LANE, SUITE 100 LEWISVILLE, TX 75056 PHONE: (940) 484-9400 FAX: (940) 566-1047	
	DRAWN BY: DFRISIELLO	03/27/2019		TITLE LF LAB 0.150" O.D. 1553 TWNX P-BLNT
	CHECKED BY: MHEARN	03/27/2019		
	APPROVED BY: MHEARN	03/27/2019		CONFIGURATION DETAILS OF UNDIMENSIONED FEATURES MAY VARY
CUSTOMER REFERENCE DOCUMENT:	CAGE CODE: 4Z977		SCALE: NTS	
SIZE A		DRAWING NUMBER: MSA00471	REV. A	
		SHEET 1 OF 1		