

2-STUB INLINE BUS COUPLER

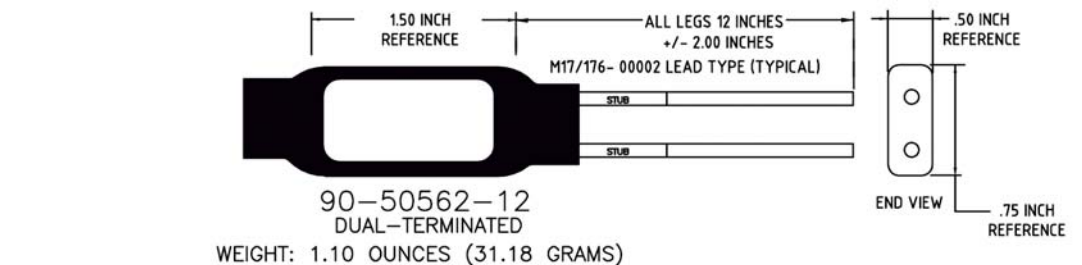
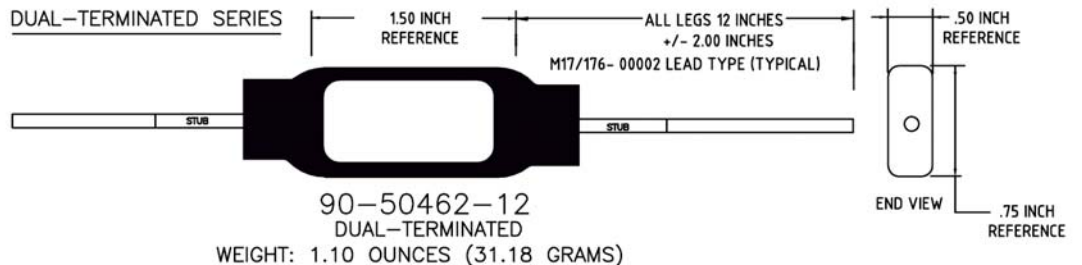
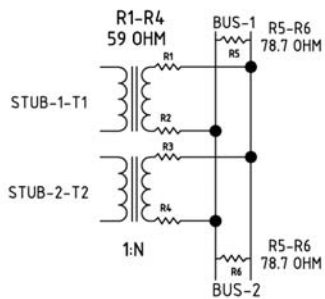
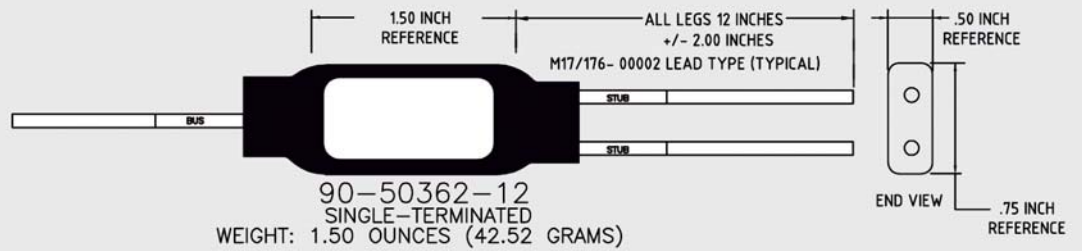
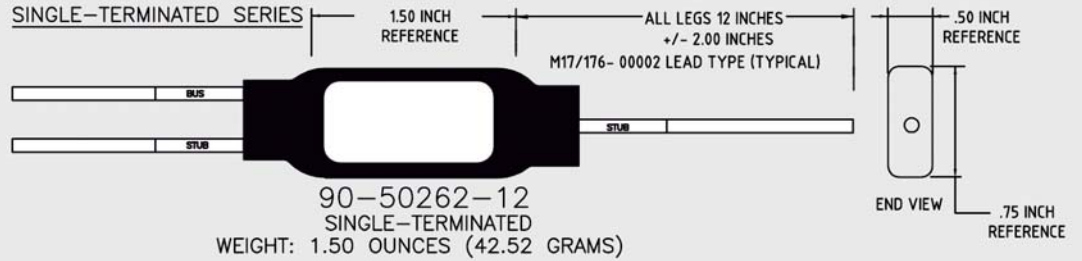
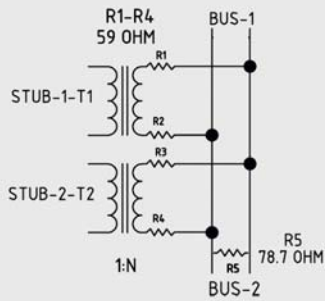
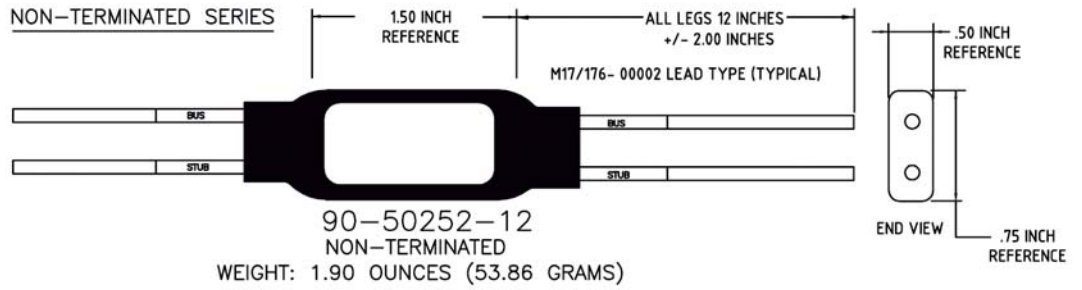
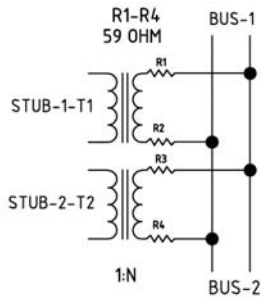

Milestek®
MILESTEK CORPORATION
1506 INTERSTATE 35 WEST
DENTON, TX 76207
PHONE: 866.524.1553
FAX: 940.591.7086

SEE CATALOG PAGE 21 FOR COUPLER SPECIFICATIONS
PLEASE VISIT www.milestek1553.com FOR ADDITIONAL INFORMATION

DRAWN BY: MIKE GREENHILL	APPROVED BY: ROBERT PEREZ	DATE 08/07/09
TITLE: 2 STUB COUPLERS	CAGE CODE: 4Z977	
DRAWING NO: 905212	ISO 9001: 2008 CERTIFIED	REV: A
SCALE: NOT TO SCALE	TOLERANCE: <.1+/.1 .01/>.1+/- .1	SHEET: 1 OF 1